

# HYPERION ONE WL

## WHITE LIGHT LED ILLUMINATOR



Energy Saving



Wall/Housing  
mount bracket



Water Proof



No External  
PSU



Maintenance  
Free

### **HIGH PERFORMANCE**

The ultimate LED technology ensures long life, outstanding reliability and low power consumption.

### **PLUG & PLAY**

The integrated power supply unit makes the installation extremely user-friendly, with no need of an external box.

### **WHITE LIGHT**

Designed to be used with color or day/night cameras, it delivers clear nighttime images up to 200meters.

### **SMART DESIGN**

The compact moulded aluminium body allows an optimal heat dissipation and maximum LEDs durability.



**tekno system**<sup>®</sup>  
Italian design for CCTV since 1979

Tekno System S.p.A.  
Via Rostoncello, 1 - 36010 Carrè - Italy  
Phone: +39 0445 314324 | Fax: +39 0445 314319  
Email: [info@teknosystem.eu](mailto:info@teknosystem.eu) | Web: [www.teknosystem.eu](http://www.teknosystem.eu)



rev. 220415

Page 1 / 3





## MODELS

ORDER CODE	Beam Angle	Max Distance	Integrated Power Supply
HYP1 15 WL	15°	200 m	100-240 VAC
HYP1 30 WL	30°	150 m	100-240 VAC
HYP1 60 WL	60°	100 m	100-240 VAC
HYP1 120 WL	120°	30 m	100-240 VAC

## ACCESSORIES

<b>BWHYP1</b>	Optional Wall Bracket for HYPERION ONE	
<b>BWRHYP1</b>	Hyperion One Adapter for LINEA R Camera Housing	

## RELATED PRODUCTS

<b>PA/1</b>	Pole mount adapter for one bracket	
<b>PA/2</b>	Pole mount adapter for two brackets	
<b>CM</b>	Corner mount adapter	
<b>CR2</b>	Photocell switch with adjustable threshold	



# TECHNICAL DATA

## GENERAL

- High efficiency SMT LEDs
- LED MTBF: 50.000 hours
- Polycarbonate optical beam collimator
- Color temperature: 6000 K
- Luminous flux: approx. 1750 lumen
- Radiant body in Aluminium die cast molding and technopolymers, for optimal thermal yield
- Wall/housing bracket included

## ELECTRICAL

- Integrated power supply: 100-240 VAC
- Power: 17 W

## MECHANICAL

- Dimensions: 192 x 195 x 83 mm
- Weight: 2,3 Kg
- Adjustable angle: No
- Beam Pattern: see table
- 1 power cable (2m; pre-wired)

## ENVIRONMENTAL

- Indoor / Outdoor applications
- IP66 and IP67 weatherproof rating (EN60529)
- Temperature range: -50 °C to 50 °C
- RoHS compliant
- CE

Technical data and product features might be modified without any warning.

## DIMENSIONS

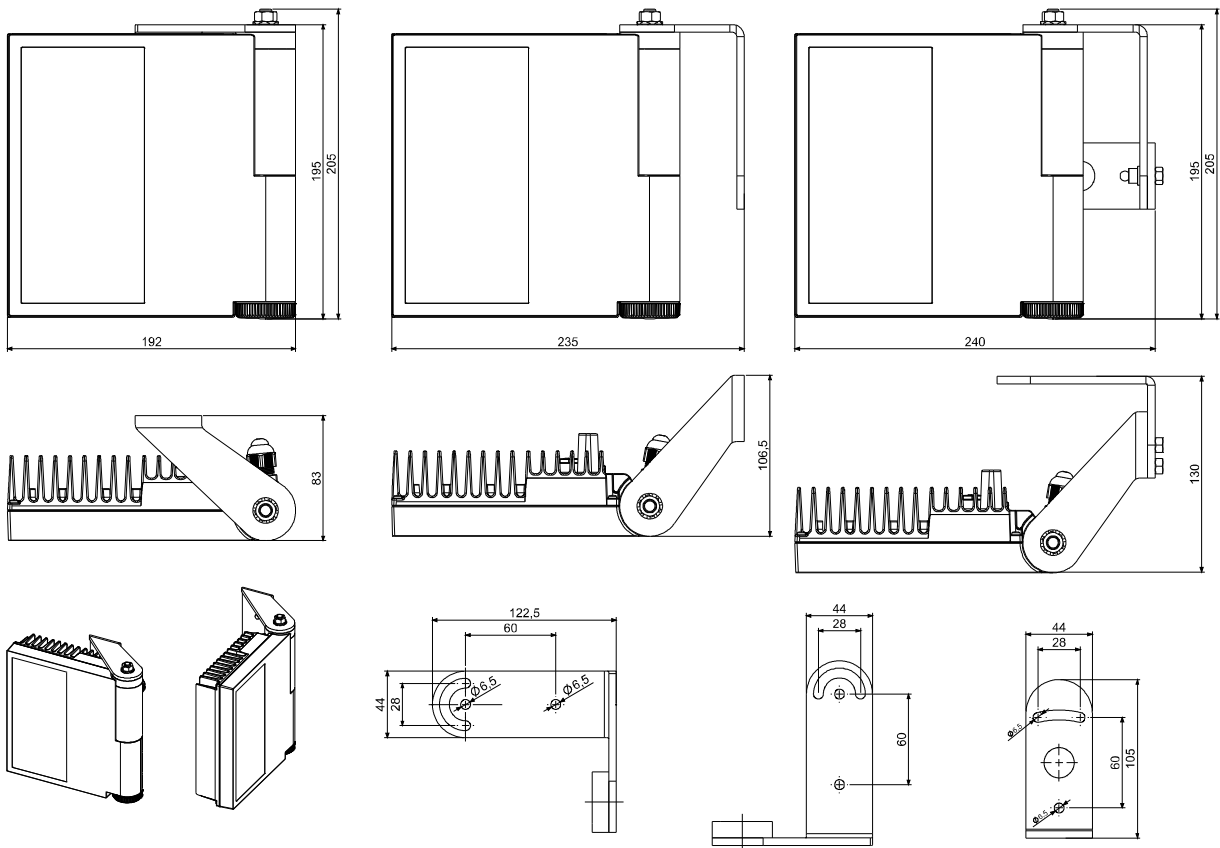

**tekno system**<sup>®</sup>  
Italian design for CCTV since 1979

Tekno System S.p.A.  
Via Rostoncello, 1 - 36010 Carrè – Italy  
Phone: +39 0445 314324 | Fax: +39 0445 314319  
Email: [info@tekno-system.eu](mailto:info@tekno-system.eu) | Web: [www.tekno-system.eu](http://www.tekno-system.eu)

rev. 220415

Page 3 / 3