

DS-2CE56C5T-VFIT3



Key Features

- 1.27 Megapixel high-performance CMOS
- Analog HD output, up to 720P resolution
- Low illumination
- 2.8 – 12mm vari-focal lens
- True Day/Night
- OSD menu, 3D DNR, Smart IR
- EXIR vari-focal technology, up to 50m IR distance
- IP66 weatherproof
- UTC function(Pelco C protocol)

Specification

Model	DS-2CE56C5T-VFIT3
Parameter	Turbo HD720p Vari-focal IR Turret Camera
Camera	
Image Sensor	1.27MP CMOS Image Sensor
Signal System	PAL/NTSC
Effective Pixels	1305(H)*977(V)
Min. Illumination	0.001 Lux @ (F1.2,AGC ON),0 Lux with IR 0.0014 Lux @ (F1.4,AGC ON),0 Lux with IR
Shutter Speed	PAL: 1/25 s to 1/50,000 s NTSC: 1/30 s to 1/50,000 s
Lens	2.8-12mm @ F1.4 Angle of view: 92° - 29.3°
Lens Mount	φ14
Angle Adjustment	Pan: 0 - 360°, Tilt: 0 - 75°, Rotation: 0 - 360°

Day & Night	ICR
Synchronization	Internal synchronization
Video Frame Rate	720p@25fps/720p@30fps
HD Video Output	1 Analog HD output
CVBS Output	1Vp-p Composite Output(75Ω/BNC)
S/N Ratio	> 62dB
Menu	
Automatic Exposure	Globe AE/DWDR
Lens Type	Auto Iris/ELC/ELC&ALC
AGC	Low/Middle/High/Off
Slow Shutter	Support
White Balance	Auto/Manual
D/N Mode	Color/BW/SMART IR
3D DNR	Low/Middle/High/Off
Motion Detection	Support, maximum 4 zones
Privacy Mask	On/Off, maximum 8 zones
UTC Function	Support
Language	English/Chinese
Function	Digital Wide Dynamic Range, 3D Digital Noise Reduction, Sharpness, Brightness, Digital Zoom, Mirror, Reset
General	
Working Temperature/Humidity	-30 °C – 60 °C (-22 °F – 140 °F) Humidity 90% or less (non-condensing)
Power Supply	12 VDC±15%
Power Consumption	Max. 6.5W
Weather Proof Ratings	IP66
IR Range	Up to 50m
Communication	Up the coax Protocol: Pelco-C(CVBS output), HIKVISION-C(TVI output)
Dimension	Φ 130.5 × 93.2 mm (Φ 5.14" × 3.67")
Weight	380 g (0.84 lb)

Order Model

DS-2CE56C5T-VFIT3

Dimension

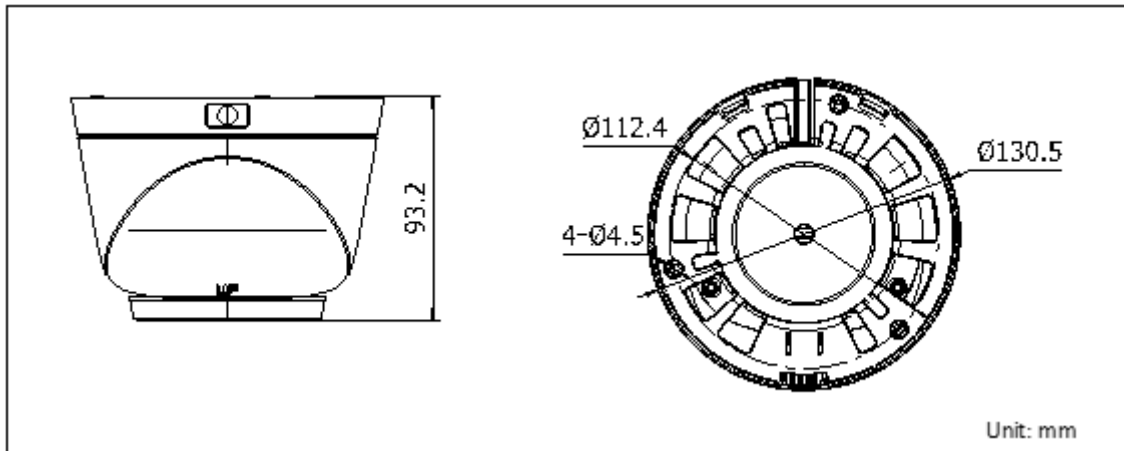

Accessory



DS-1273ZJ-130-TRL
Wall Mounting



DS-1275ZJ
Vertical Pole Mounting



DS-1276ZJ
Corner Mounting



DS-1280ZJ-M
Junction Box



DS-1281ZJ-M
Inclined Ceiling Mounting



DS-1H33
Video Balun



DS-TT-X41T
TVI Tester