

DS-2CE56D5T-IT3



Key Features

- 2 Megapixel high-performance CMOS
- Analog HD output, up to 1080P resolution
- True Day/Night
- OSD menu, 3D DNR, Smart IR
- True WDR, up to 120dB
- EXIR technology, up to 40m IR distance
- IP66 weatherproof
- UTC function(Pelco C protocol)

Specification

Model	DS-2CE56D5T-IT3
Parameter	Turbo HD1080p EXIR Turret Camera
Camera	
Image Sensor	2MP CMOS Image Sensor
Signal System	PAL/NTSC
Effective Pixels	1944(H)*1092(V)
Min. Illumination	0.01 Lux @(F1.2,AGC ON), 0 Lux with IR
Shutter Time	1/25(1/30) s to 1/50,000 s
Lens	3.6mm (2.8mm, 6mm, 8mm, 12mm, 16mm optional)
	Angle of View: 82.6°(3.6mm), 103.5°(2.8mm), 54.4°(6mm), 38°(8mm), 24.4°(12mm), 18.9°(16mm)
Lens Mount	M12
Angle Adjustment	Pan: 0 - 360°, Tilt: 0 - 75°, Rotation: 0 - 360°
Day & Night	ICR
Synchronization	Internal synchronization
WDR	120dB

Video Frame Rate	1080p@25fps/1080p@30fps
HD Video Output	1 Analog HD output
CVBS Output	1Vp-p Composite Output(75Ω/BNC)
S/N Ratio	> 62dB
Menu	
Scene	Indoor, Outdoor, Indoor1, LOW-LIGHT
Camera ID	On/off (15 characters, position programmable)
AGC	Support
D/N Mode	Color/BW/EXT
White Balance	ATW, AWC-SET, Indoor, Outdoor, Manual
Privacy Mask	On/Off, maximum 8 zones
Motion Detection	On/Off, maximum 4 zones
BLC	Support
Anti-flicker	On/off
Language	English, Japanese, CHN1, CHN2, Korean, German, French, Italian, Spanish, Polish, Russian, Portuguese, Dutch, Turkish, Hebrew and Arabic
Functions	Eclipse, Digital noise reduction, Digital zoom(62x), Slow shutter, Mirror, Defog, Defect pixel correction, SMART D-ZOOM
General	
Working Temperature/Humidity	-30 °C – 60 °C (-22 °F – 140 °F) Humidity 90% or less (non-condensing)
Power Supply	12V DC±15%
Power Consumption	Max. 5W
Weather Proof Ratings	IP66
IR Range	Up to 40m
Communication	Up the coax Protocol: Pelco-C(CVBS output), HIKVISION-C(TVI output)
Dimension	Φ114.6 × 89.1mm(Φ4.5" × 3.5")
Weight	420 g (0.93 lb)

Order Model

DS-2CE56D5T-IT3

Dimension

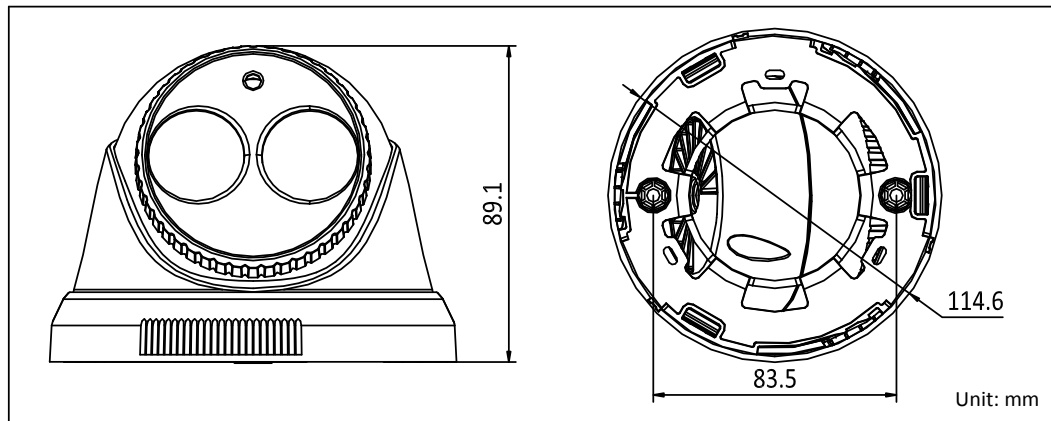

Accessories



DS-1272ZJ-110
Wall Mounting



DS-1275ZJ
Vertical Pole Mounting



DS-1276ZJ
Corner Mounting



DS-1280ZJ-S
Junction Box



DS-1258ZJ
Wall Mounting



DS-1281ZJ-S
Inclined Ceiling Mounting



DS-1H33
Video Balun



DS-TT-X41T
TVI Tester